

Additional Information

- 1) Make sure your scale is at room temperature, and on a stable horizontal surface free of vibration.
- 2) This scale is not waterproof. Do not expose to moisture.
- 3) As this scale is a precision instrument, it must be handled with extreme care. Avoid rough treatment, shaking and vibration.
- 4) Do not disassemble this scale or the warranty will be void.
- 5) The display value may be affected by electromagnetic disturbances such as operating near a radio. If this occurs, move the device that is causing the disturbance and turn the scale off and restart.

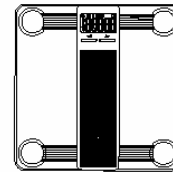

see www.escali.com for full details
 © Copyright Escali LLC, 2006

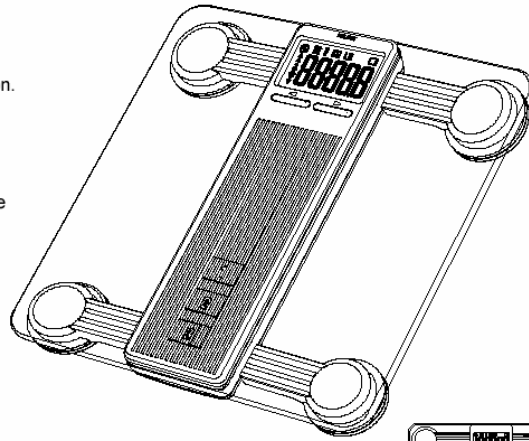

**TT200
 Target & Track Bathroom scale**

User's guide

OPERATING INSTRUCTIONS

FULL DISPLAY

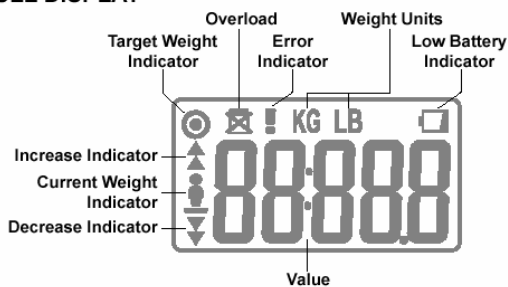

FUNCTION KEYS

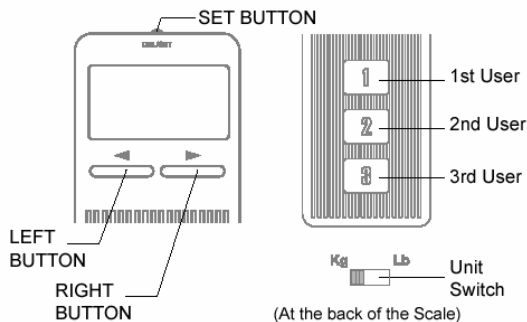

SPECIFICATIONS

1. Capacity: 200KG / 440LB
2. Resolution: 0.1kg / 0.2lb
3. Operation temperature: 0~40°C
4. Power supply: 2 x CR2032 batteries
5. Weight units: KG, LB
6. Auto off in 8 seconds if no operation
7. Number of User Memory: 3

TO CHANGE BATTERIES

Ensure +/- terminals are correct way round.
 Use proper tool to help release the batteries from the compartment if necessary.

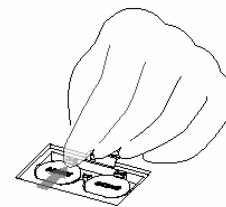

TO SET TARGET WEIGHT

1. Press **1** **2** **3** to select user account. Or after weighing.



2. Press and hold **ON** for 3 sec to enter target weight setting.



3. Use **←** **→** to adjust the target weight.



4. Press **OK** to confirm the setting.



5. The scale will auto-power-off in 20 seconds if no further operation.

TO WEIGH ONLY

1. Tap on the platform of the scale to turn it on. The LCD display shows full display.



2. When LCD shows '0.0', step on to the platform and stand still.



3. Weight will be displayed and locked. Step off from scale.



4. The scale will auto-power-off in 6 seconds if no further operation.

TO SELECT WEIGHT UNIT

Use the switch at the back of the scale to choose the weight unit.



3

4

TO WEIGH WITH WEIGHT TRACK FUNCTION

1. Press **1** **2** **3** to select user account. (You can change the user account by pressing **1** **2** **3** anytime.)

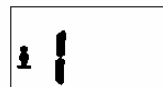

2. When LCD shows '0.0', step on to the platform and stand still.

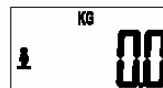

3. Weight will be displayed and locked. Step off from scale. Please follow "TO SELECT WEIGHT UNIT" section to change the unit.



Overload

4. The comparison result with the current and last record is showed.

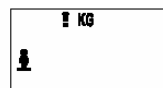

No last record for comparison



The current result is 1kg lower than the last record.



The current result is 2kg higher than the last record.

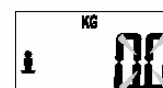

The current result is as same as the last record.

5. Then the comparison result with the current and target weight is showed.

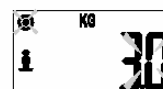

The current result is 3kg either higher or lower than the target weight.

"BiBi" sound is given when the current result is as same as the target weight.

Please follow "TO SET TARGET WEIGHT" section to change the target weight.

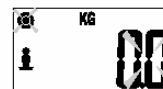

The current result is as same as the target weight.

6. Press **ON** button to review the target weight while the result is showing.



5

6